

SIEMENS

Siemens Panel Builder Program

P2, P3, P4, P5 Panelboards
and Switchboards

AMPLIFY

Power Distribution Panel Program

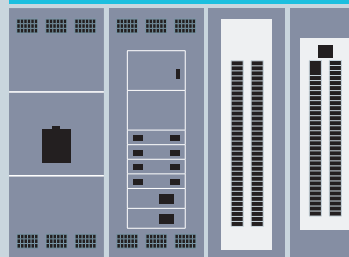

usa.siemens.com/panelboards

This document covers Siemens AMPLIFY program for P2, P3, P4, P5 Panelboards and Switchboard products

Your partnership with Siemens provides access to over 170 years of innovation, flexibility, reliability, and safety expertise. Leverage Siemens UL certified designs to maximize your manufacturing process – an extensive database of existing OEM files is available for you to use in conjunction with your own designs to build UL-listed panelboards and switchboards.

The program is flexible – buy only the parts you need. This document covers the most purchased parts from the program, if others are needed contact your sales representative.

P2 & P3 Lighting Panelboard Kits

The P2 and P3 branch breaker kits are broken out with the Distributor kit as the single mounting kit that is for 3" or 6 poles of the smaller 1" per pole breakers or 6" for breakers larger than 1" per pole (>125 amp frames) for up to 3 poles of single mounted and 6 poles of twin mounted breakers. The kits are then broken down into individual parts available

for sell. These parts are typically the bus, molded or highly tooled parts. Note that parts may have more than one number assigned based on quantity. Not every part number under the kit line needs to be ordered for a given kit. Drawings are available for those parts that are more simple to make and typically made by the OEM.

Breaker kits and parts

Cat/Part number	Description	Qty per	Reference drawing
BBKB32	P2/P3 BL/BQD Branch Strap kit, uses 3" of unit space for 6 circuits total	1 kit	11-D-2267-01
K11A405503	P2/P3 BL/BQD B-phase Branch Bus strap CU	200	
K11A405603	P2/P3 BL/BQD A/C-phase Branch Bus strap CU	200	
K11D451801	P2/P3 BL/BQD Support Barrier, Black, 3" unit space	360	
K11D451801SP	P2/P3 BL/BQD Support Barrier, Black, 3" unit space	8	
BBKVA4P2P3	P2/P3 xGB/3VA41 6-pole Strap Kit w/barrier, 1-ph or 3-ph (use w/ xGB & 3VA41 breakers)	1 Kit	13-D-2011-13
K11D275701	P2/P3 P2/P3 xGB/3VA41 3-Phase Branch Kit (does not include barrier)	10	
K11D378702	P2/P3 xGB/3VA41 A/C Connector CU Tin Plate	150	
K11D378702SP	P2/P3 xGB/3VA41 A/C Connector CU Tin Plate	12	
K11D378902	P2/P3 xGB/3VA41 B PH Connector CU Tin Plated	125	
K11D378902SP	P2/P3 xGB/3VA41 B PH Connector CU Tin Plated	12	
K11D461801	P2/P3 xGB/3VA41 Barrier, packed 20/ctn (also used with P4/P5/SWBD)	20	
Note: P2/P3 Strap kits include the CU connectors above. AL connectors below are allowed in P2/P3 but not P4/P5/SWBD			
K11D378601	P2/P3 xGB/3VA41 A/C Connector AL	100	
K11D378601SP	P2/P3 xGB/3VA41 A/C Connector AL	12	
K11D378801	P2/P3 xGB/3VA41 B PH Connector AL	100	
Note: P2/P3 Barriers listed below are being phased out - Customers should convert to the Barriers for 3VA41/xGB ASAP			
K12D450001	P2/P3 Barrier XGB only (to be phased out) use K11D461801	50	
K12D450001SP	P2/P3 Barrier XGB only (to be phased out) use K11D461801	10	
BBKQR1	P2 QR Single Mount Branch Strap Kit, uses 6" of unit space for one 2-pole or 3-pole breaker.	1 kit	11-D-2636-01
K11D369901	P2 QJ/QR A/C Phase Connector Long, .25" CU Tin plated, w/tape insulation	30	
K11D370101	P2 QJ/QR B Phase Connector, .25" CU Tin plated	4	
K11D370301	P2 QJ/QR A/C Phase Connector Short, .25" CU-Tin plated	6	
K11D306401	P2 QJ/QR Branch Breaker Support, 12GA Galv, 2.25"x2.25"x1.23"	6	
K11A186901	Narrow 350 kcmil Lug w/o mounting screws, Bulk 50 pcs/carton, (ILSCO D3742A22T)	50	
BNK350N	Narrow 350 kcmil Lug w/2 mounting screws	1 kit	

Breaker kits and parts

Cat/Part number	Description	Qty per	Reference drawing
BBKQR2	P3 QR Twin Mount Branch Strap Kit, uses 6" of unit space for two 2-pole or 3-pole breakers	1 kit	11-D-2637-01
K11D374301	P3 A/C QR Bus Connector, Type B (use two for 3-ph and one for 1-ph kit)	50	
K11D374301SP	P3 A/C QR Bus Connector, Type B (use two for 3-ph and one for 1-ph kit)	20	
K11D374501	P3 B-phase QR Bus Connector, (use one for each 3-ph kit)	50	
K11D374501SP	P3 B-phase QR Bus Connector, (use one for each 3-ph kit)	20	
K11D374701	P3 A/C QR Bus Connector, Type A (use one for each 1-ph kit)	50	
K11D374701SP	P3 A/C QR Bus Connector, Type A (use one for each 1-phase kit)	20	
K11D374901	P3 QR Dual Phase Connector, (use one per phase)	20	
K11D374901SP	P3 QR Dual Phase Connector, (use one per phase)	20	
K11D307401	P3 QR Breaker Support, steel bracket (use one per breaker)	150	
K11D307401SP	P3 QR Breaker Support, steel bracket (use one per breaker)	20	
K11D452601	P3 DUAL QR Branch Barrier	100	
K11D452601SP	P3 DUAL QR Branch Barrier	20	
K11D456501	P3 QR Deadfront Filler	368	
K11D456501SP	P3 QR Deadfront Filler	20	
K11A186901	Narrow 350 kcmil Lug w/o mounting screws, Bulk 50 pcs/carton, (ILSCO D3742A22T)	50	
BBKVA5262P2S	P2/P3 Single Mnt 3VA52/61/62 Strap Kit, 1ph or 3ph, (Field kit for Branch only applications) (this set of parts can be used for OEM Main, horizontal mount in unit space)	1 kit	11-D-2881
K11D288101A	OEM P2/P3 Strap Kit 3-PH 3VA52/61/62, Horizontal Main or Branch (does not include Deadfront plate or filler)(for OEM- same kit can be used for Main Breaker in unit space)	5	
K11D288103A	OEM P2/P3 Strap Kit 1-PH 3VA52/61/62, Horizontal Main or Branch (does not include Deadfront plate or filler)(for OEM- same kit can be used for Main Breaker in unit space)	5	
BBKVA5262P2HW	P2/P3 3VA52/61/62 Hardware Kit, 1ph/3ph, required 1 per breaker for Single mount kits (not included with OEM kits above)(also used in P2/P3 Vertical Mount Main kits)	1 kit	11-D-2881
K11D333101SP	P2 Single Mount 3VA52/61/62 Deadfront Plate	5	
K11D333102SP	P3 Single Mount 3VA52/61/62 Deadfront Plate	5	
K11D461001	OEM Filler 3VA52/61/62 P2/P3, Bulk packed 148/carton (ref DFFPVA5262P2A)	148	
K11D461001SP	OEM Filler 3VA52/61/62 P2/P3, Bulk packed 25/carton (ref DFFPVA5262P2A)	25	
DFFPVA5262P2B	P2/P3 3VA52/61/62 Blank Plate/Barrier Note: required when used as a provision, kit installed without breaker	1	
BBKVA52P3T	P3 Twin Mount 3VA52 250A max. Strap Kit for Field installation. Mounts two 3VA52 breakers in 6" of unit space Nose-to-Nose. Includes two BBKVA52P3HW kits, one for each breaker.	1 kit	11-D-2764-01
K11D458501	3VA52 P3 Twin Mount Top Barrier, packed 24 per carton	24	
K11D458501SP	3VA52 P3 Twin Mount Top Barrier, packed 12 per carton	12	
K11D397501	3VA52 P3 A/C-phase Strap, CU Tin Plated, packed 25 per carton	25	
K11D397501SP	3VA52 P3 A/C-phase Strap, CU Tin Plated, packed 12 per carton	12	
K11D397701	3VA52 P3 B-phase Strap, CU Tin Plated, packed 25 per carton	25	
K11D397701SP	3VA52 P3 B-phase Strap, CU Tin Plated, packed 6 per carton	6	
BBKVA52P3HW	3VA52 Twin Mount P3 - Hardware Kit, one kit per breaker needed. Two are included with Strap kit BBKVA52P3T	1 kit	11-D-2763-01
US2:K11D276301SP	3VA52 P3 Twin Mnt Brkr Hdw Kit	12	

Branch breaker kits and parts – Legacy

BBKED32 ¹	P2/P3 ED Twin Mount Branch Strap Kit, uses 3" of unit space for 6 circuits.	1 kit	11-D-2268-01
K11401103	P2/P3 ED B Phase CU BUS Connector, tin plate	50	
K11D377301	P2/P3 ED A/C Phase CU BUS Connector, tin plate	200	
K11D377301SP	P2/P3 ED A/C Phase CU BUS Connector, tin plate	24	
K11D452101	P2/P3 ED 1-pole Barrier, 1-phase systems only, Main and Branch, Black	100	
K11D461301	DFFP1A Filler Plate for BL/BQD/ED/xGB/3VA41 in PNLBD & SWBD deadfronts, plus many other locations	1000	
K15450201	P2/P3 ED 1-pole Barrier, 3-phase systems only, Main and Branch, Black	240	
BBKGB32 ²	P2/P3 GB2 Twin Mount Branch Strap Kit, uses 3" of unit space for 6 circuits. Includes xGB Barrier and all mounting hardware.	1 kit	11-D-2756-01
K11D378702	P2/P3 xGB A/C-Phase Branch Connector, CU tin plated, also used for P2 Horiz. Mount Main, Bulk 150 pcs/carton	150	
K11D378702SP	P2/P3 xGB A/C-Phase Branch Connector, CU tin plated, also used for P2 Horiz. Mount Main, Bulk 12 pcs/pack	12	
K11D378902	P2/P3 xGB B-Phase Branch Connector, CU tin plated, also used for P2 Horiz. Mount Main, Bulk 150 pcs/carton	150	
K11D378902SP	P2/P3 xGB B-Phase Branch Connector, CU tin plated, also used for P2 Horiz. Mount Main, Bulk 12 pcs/pack	12	
K11D458601SP	P2/P3 GB2 Twin Mount Branch Kit Top Barrier, Bulk 10 pcs/carton	10	
BBKNB32 ²	P2/P3 xGB Twin Mount Branch Strap Kit, uses 3" of unit space for 6 circuits. Includes xGB Barrier and all mounting hardware.	1 kit	11-D-2755-01
K11D378702	P2/P3 xGB A/C-Phase Branch Connector, CU tin plated, also used for P2 Horiz. Mount Main, Bulk 150 pcs carton	150	
K11D378702SP	P2/P3 xGB A/C-Phase Branch Connector, CU tin plated, also used for P2 Horiz. Mount Main, Bulk 12 pcs/pack	12	
K11D378902	P2/P3 xGB B-Phase Branch Connector, CU tin plated, also used for P2 Horiz. Mount Main, Bulk 150 pcs/carton	150	
K11D378902SP	P2/P3 xGB B-Phase Branch Connector, CU tin plated, also used for P2 Horiz. Mount Main, Bulk 12 pcs/pack	12	
K12D450001	P2/P3 xGB Twin Mount Branch Kit Top Barrier, Bulk 48 per carton	48	
K12D450001SP	P2/P3 xGB Twin Mount Branch Kit Top Barrier, Bulk 10 per carton	10	
BBKVA52P3HW	3VA52 Twin Mount P3 - Hardware Kit, one kit per breaker needed. Two are included with Strap kit	1 kit	11-D-2763-01
US2:K11D276301SP	3VA52 P3 Twin Mnt Brkr Hdw Kit	12	

¹ This assembly is being obsoleted.

² This kit to be replaced by BBKVA4P2P3.

Main Breaker Kits and Parts

3VA52/61/62 150A/250A frame Horizontal mains in P2/P3

Cat/Part number	Description	Qty per
BBKVA5262P2S	P2/P3 Single Mnt 3VA52/61/62 Strap Kit, 1ph or 3ph, (Field kit for Branch only applications) (this set of parts can be used for OEM Main, horizontal mount in unit space)	1 kit/ctn
K11D288101A	OEM P2/P3 Strap Kit 3-PH 3VA52/61/62, Horizontal Main or Branch (Does not include Deadfront plate or filler)(for OEM- same kit can be used for Main Breaker in unit space)	5/carton
K11D288103A	OEM P2/P3 Strap Kit 1-PH 3VA52/61/62, Horizontal Main or Branch (does not include Deadfront plate or filler)(for OEM- same kit can be used for Main Breaker in unit space)	5/carton
BBKVA5262P2HW	P2/P3 3VA52/61/62 Hardware Kit, 1ph/3ph, required 1 per breaker for Single mount kits (Not included with OEM kits above)(also used in P2/P3 Vertical Mount Main kits)	
K11D333101SP	P2 Single Mount 3VA52/61/62 Deadfront Plate	5/carton
K11D333102SP	P3 Single Mount 3VA52/61/62 Deadfront Plate	5/carton
K11D461001	OEM Filler 3VA52/61/62 P2/P3, (ref DFFPVA5262P2A for 1pce kit)	148/carton
K11D461001SP	OEM Filler 3VA52/61/62 P2/P3, (ref DFFPVA5262P2A for 1pce kit)	25/carton
DFFPVA5262P2B	P2/P3 3VA52/61/62 BLANK PLATE/BARRIER, 1 kit/bag Note: required when used as a branch provision, kit installed without breaker	25 bags/ctn
SEBKP2V7	P2/P3 Service Entrance Barrier kit for Horizontal Mount 3VA52/61/62	1 kit/ctn

3VA52/61/62 150A/250A frame Vertical mains in P2/P3

Cat/Part number	Description	Qty per
K11D288301A	P2/P3 3VA52/61/62 Vertical Mount Main Strap Kit (does not include Deadfront plate or filler)	5/ctn
BBKVA5262P2HW	P2/P3 3VA52/61/62 Hardware Kit, 1ph/3ph, required 1 per breaker for Single mount kits (not included with OEM kits above) (also used in P2/P3 Vertical Mount Main kits)	
DFFPVA5262P2A	P2/P3 3VA52/61/62 FILLER, for Single Mount only	1 pce/kit
SEBKP1P2P3V1	P1/P2/P3 Service Entrance Barrier kit, Vertical Mount 3VA52/61/62, 3VA53/63/54/64	1 kit/ctn

3VA53/63/54/64 400A/600A frame Vertical mains in P2/P3

Cat/Part number	Description	Qty per
K11D286201	P2/P3 3VA53/63 400A Vertical Mount strap kit (P3 requires MB adapter below)	5/ctn
K11D330401	P3 3VA53/63 400A Vert Main Breaker Adapter (required with P3 only in kit above) Note: OEM Strap kits do not include Deadfront Plates or Breaker mounting hardware	5/ctn
K11D286301	P2 3VA54/64 600A 1-phase Vertical Mount Strap Kit	1 kit/ctn
K11D286302	P2 3VA54/64 600A 3-phase Vertical Mount Strap Kit	1 kit/ctn
K11D286501	P3 3VA54/64 600A 1-phase Vertical Mount Strap Kit	1 kit/ctn
K11D286502	P3 3VA54/64 600A 3-phase Vertical Mount Strap Kit	1 kit/ctn
SEBKP1P2P3V1	P1/P2/P3 Service Entrance Barrier kit, Vertical Mount 3VA52/61/62, 3VA53/63/54/64	1 kit/ctn

3VA53/63/54/64 400A/600A frame Horizontal mains (or subfeed) in P3 only

Note: 600A Horizontal Main or Subfeed requires minimum 30" wide enclosure

Cat/Part number	Description	Qty per
K11E200402	P3 3VA53/63 400A 1-phase horizontal mount strap kit, no Barrier	5/ctn
K11E200401	P3 3VA53/63 400A 3-phase horizontal mount strap kit, no Barrier	5/ctn
K11D462301	P3 3VA53/63/54/64 Horizontal Mount Barrier only, bulk packed	xx pcs/ctn
K11D462301SP	P3 3VA53/63/54/64 Horizontal Mount Barrier only, bulk packed	5 pcs/ctn
K11E200501	P3 3VA54/64 600A Horizontal mount strap kit upgrade, 1-ph or 3-ph, use with 400A Horizontal strap kits to allow full 600A max. capacity	5 kits/ctn
DFFPVA5363P3B	P3 3VA53/63 Bland Plate/Barrier for Horizontal Mount Note: required when used as a subfeed provision kit installed without breaker	1 kit/ctn
SEBKP3V2	P3 3VA53/63/54/64 Service Entrance Barrier Kit includes bracket, barrier and hardware. For top or bottom feed, single or three phase panels.	

3VA55/65 800A frame Vertical mains in P3 only

Note: 800A 3VA55 TMTU only, requires vented 30" wide enclosure per Siemens UL file

Cat/Part number	Description	Qty per
K11D2986011	P3 3VA55/65 800A Vertical Main strap kit, 1-phase or 3-phase, Note: OEM Strap kits do not include Deadfront Plates or Breaker mounting hardware	1 kit/ctn
SEBKP3V3	P3 3VA55/65 800A Service Entrance Barrier Kit, vertical mount	1 kit/ctn

P2/P3 Dead front fillers and miscellaneous parts

Cat/Part number	Description	Qty per
DFFP1A	DFFP1A 1" Filler Plate for BL/BQD/ED/xGB in PNLBD & SWBD deadfronts. Sold per piece.	1
K11D461301	DFFP1A 1" Filler, OEM Filler Plate for BL/BQD/xGB/3VA41 in PNLBD & SWBD deadfronts, plus many other locations	1000 pcs/ctn
DFF3AP01	P3 BL/GB/3VA4 Adaptor Plate 3-inches of unit space (rev 11-D-3033-01)	1 pc
DFFPVA5262P2A	P2/P3 Single Mount 3VA52/61/62 Filler, 1 pce per kit (ref 11-D-4610-01)	25 kits/carton
K11D461001	P2/P3 Filler, single mount 3VA52/61/62 in P2/P3, for OEM use (ref 11-D-4610-01)	148/carton
K11D461001SP	P2/P3 Filler, single mount 3VA52/61/62 in P2/P3, for OEM use (ref 11-D-4610-01)	20/carton
DFFPVA5262P2B	P2/P3 3VA52/61/62 Blank Plate/Barrier, 1 kit/bag Note: required when used as a branch provision, kit installed without breaker	25 bags/ctn.
DFFPVA5363P3B	P3 3VA53/63 Blank Plate/Barrier for Horizontal Mount Note: required when used as a subfeed provision kit installed without breaker	1 kit/ctn
P2QRFP01	P2 QR Deadfront Filler, Plastic snap-in for P2, Vertical mount Main position	one filler per pkg
K11D456401	P2 QR Deadfront Filler, Plastic snap-in for P2, Vertical mount Main position	368 per carton
K11D456401SP	P2 QR Deadfront Filler, Plastic snap-in for P2, Vertical mount Main position	20 per carton
BNK2	Neutral Lug Kit, 3-Step, for P2 neutrals and others, packed 1 per kit (ref. 11-A-1862-01) (14x #14-1/0 max and 14x #14-#6 max connections) - Kit includes mounting hardware and instructions	10 kits/ctn
K11A186201	P2 BNK2 neutral 3-step Lug includes 14x1/O max. and 14x#6 max. connections These are lugs only without mounting screws (ref. 11-A-1862-01)	80/ctn
BNK350N	Neutral Lug kit, Narrow 350 kcmil Lug with two mounting screws, packed 1 per kit Used in P2/P3 neutrals and other locations.(ref. 15-A-1800-01)	20 kits/ctn
K11A186901	Narrow 350 kcmil Lug w/o mounting screws, (ILSCO D3742A22T) (ref. 15-A-1800-01)	50/ctn
LPP2NB01	Neutral Lug kit, 2-Step, for P2 neutrals and others , packed 1 per kit (ref. 15-A-1800-01) (3x #6-1/0 max and 18x #14-#6 max connections) - Kit includes mounting hardware and instructions	10 kits/ctn
K15A180001	2-Step Lug, for P2 Neutrals and others (ref 15-A-1800-01) (3X #6-1/0 Max and 18X #14-#6 Max connections) - No Mounting hardware	125/ct

Service entrance barriers for use with main breakers when service entrance required

Cat/Part number	Description	Qty per
SEBKP2V7	P2/P3 Service Entrance Barrier kit for Horizontal Mount 3VA52/61/62, packed 1 kit/ctn	1
SEBKP1P2P3V1	P1/P2/P3 Service Entrance Barrier kit for Vertical Mount 3VA52/61/62 3VA52/63/64, packed 1 kit/ctn	1
SEBKP3V2	P3 3VA53/63/54/64 Service Entrance Barrier Kit includes bracker, barrier and hardware. For top or bottom feed, single or three phase panels.	1
SEBKP3V3	P3 3VA55/65 Service Entrance Barrier Kit, vertical mount. Packed 1 kit/ctn	1

P4 & P5 Power Panelboards and Switchboard Kits

Contains all parts necessary to connect the breaker to the panel's bus.

Bus kits: Contain all the current carrying parts and any hard tooled items, such as molded barriers, die-made steel parts and specialty hardware. Will contain barrier support if top barrier is included.

Steel kits: include any steel or non-current carrying parts that do not require a mold or costly die to make. Typically these parts can be made on universal tooling such as punch and press brakes.





Hardware kits: Contain readily available hardware (not specialty items) needed for the assembly: common thread forming screws, machine screws, hex nuts, etc.

3VA Breaker Provision Kit: Contains the hardware, nut keepers and bus extensions to land the breaker to the strap kit.

Provision Kits:

Includes hardware and accessories for installing 3VA breakers to an existing provision in the field. Parts are included with Panelbuilder Kits (Ref. Fig 1).

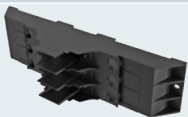
Key component definitions

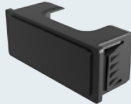
Runback	Aluminum or Copper electrical connector between Main Bus and Phase Straps	
Phase Straps	Aluminum or Copper electrical connector for each phase (A, B, & C) between breaker and Main Bus or breaker and Runback	
Top Barrier	Special tooled, nonconductive part that in most cases locates and aligns the breaker to the Phase Straps while providing isolation between the Phase Straps	
Cover Plate	A steel part providing closure of the deadfront assembly	
Filler Provision Plate	A steel or plastic part providing closure to the deadfront when a breaker provision is installed	

3VA Breaker Family

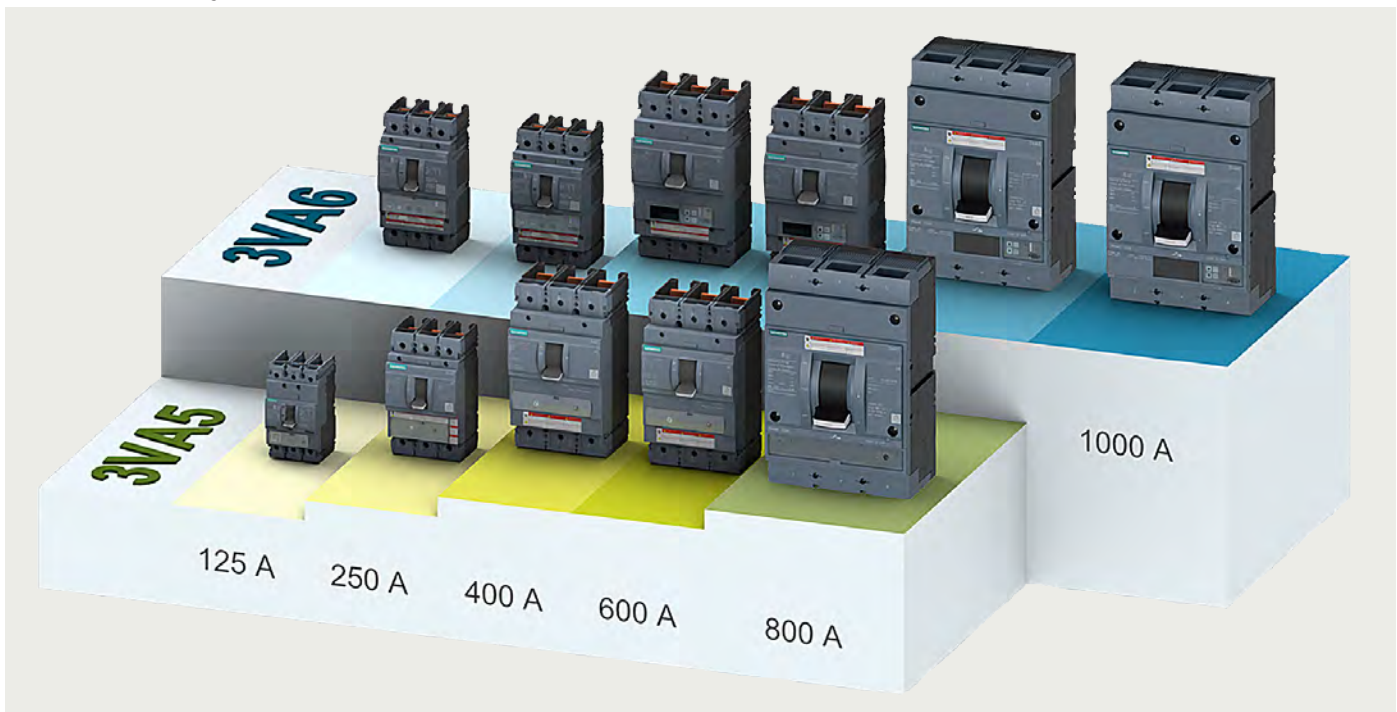

P4 Power Panelboards Circuit Breaker Kits – these kits contain parts to connect the breaker to the distribution bus.

New release – 3VA							
Panel Type	Breakers Family	Max. Volts	Max. Amps	Mounting	Distributor Kit	Panelbuilder Kit	Bus Kit
P4	3VA41, xGB ¹	600	125	Twin	S3VA41T	KS3VA41T	KS3VA41TB
	3VA61	600	150	Twin	S3VA52T	KS3VA52T	KS3VA52TB
	3VA52, 3VA62	600	250	Twin	S3VA52T	KS3VA52T	KS3VA52TB
	3VA53, 3VA63	600	400	Single	TBD	TBD	TBD
	3VA54, 3VA64	600	600	Single	TBD	TBD	TBD

¹ Strap Kit can also accommodate xGB breakers, reference Installation Instructions.

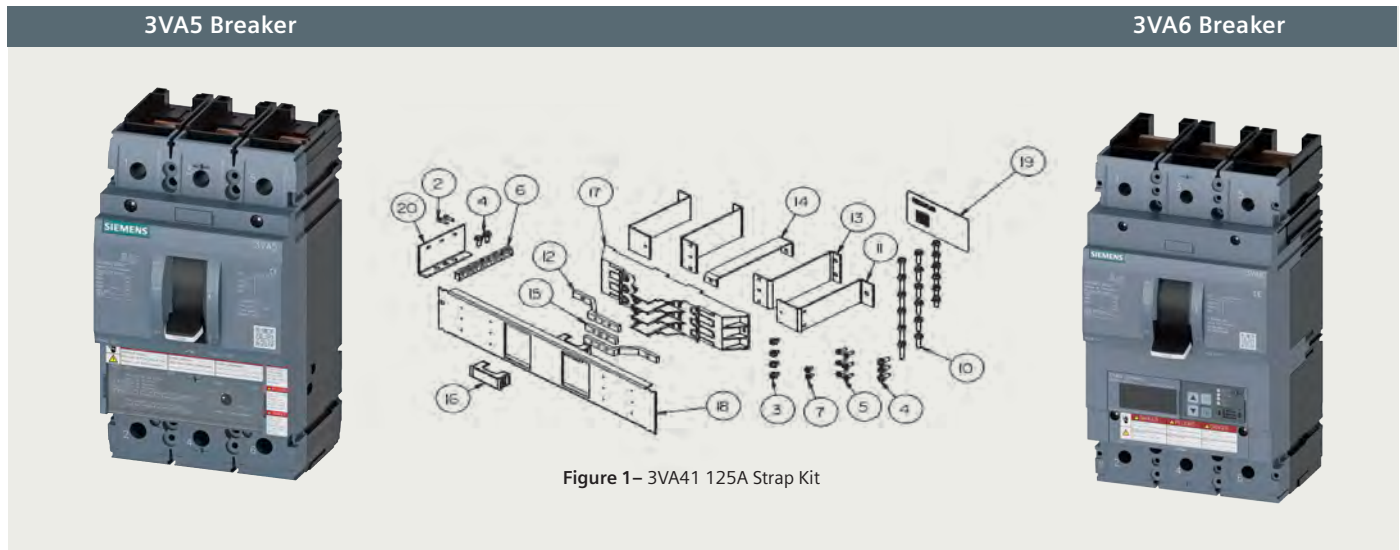

Figure 1 – 3VA41 125A Strap Kit

P4 Power Panelboards Circuit Breaker Kits – these kits contain parts to connect the breaker to the distribution bus.

Panel Type	Existing / legacy Breakers	Max. Volts	Current Rating	Distributor Kit	Panelbuilder Kit	Hardware Kit	Steel Kit	Bus Kit	Aluminum Bus Kit
P4	BL	240	100	SBL	KSBL	—	—	KSBLB	—
	BQD	480	100	SBL	KSBL	—	—	KSBLB	—
	ED	600	125	SE6	KSE6	KSE6H	KSE6S	KSE6B	KSE6B-A
	CED	600	125	SCE	KSCE	—	KSCES	KSE6B	—
	DG	600	150	SDG	KSDG	KSDGH	KSDGS	KSDGB	—
	QR	240	225	SQR	KSQR	KSQRH	KSQRS	KSQRB	—
	FD	600	250	SF6	KSF6	KSF6H	KSF6S	KSF6B	KSF6B-A
	CFD	600	250	SCF	KSCF	KSCFH	KSCFS	KSCFB	—
	FG	600	250	SFG	KSFG	KSFGH	KSFGS	KSFBG	—
	JD	600	400	SJ1	KSJ1	KSJ1H	KSJ1S	KSJ1B	—
	CJD	600	400	SCJ	KSCJ	—	KSCJS	KSCJB	—
	SJD	600	400	SSJ1	KSSJ1	KSJ1H	KSSJ1DS	KSJ1B	—
	SCJD	600	400	SCJD	KSCJD	KSCJDH	KSCJDS	KSCJDB	—
	JG	600	400	SJG	KSJG	KSJGH	KSJGS	KSJGB	—
	LD	600	600	SL6	KSL6	KSL6H	KSL6S	KSL6B	—
	SLD	600	600	SSL6	—	KSL6H	—	KSL6B	—
	CLD	600	600	SCL	KSCL	KSCJDH	KSCLS	KSCLB	—
	SCLD	600	600	SSCL	KSSCL	KSCJDH	KSSCLS	KSCJDB	—
	LG	600	600	SLG	KSLG	KSLGH	KSLGS	KSLGB	—
	MG	600	800	MG1	KMG1	KMG1H	KMG1S	KMG1B	—

Note: When parts are not available use the full Panelbuilder kit. Distributor kit instructions can be used for installation and are available on the download center.

P5 Power Panelboards and Switchboard Circuit Breaker Kits – these kits contain parts to connect the breaker to the distribution

New release – 3VA							
Panel Type	Breakers Family	Max. Volts	Max. Amps	Mounting	Distributor Kit	Panelbuilder Kit	Bus Kit
P5 / SWBD	3VA41, xGB ¹	600	125	Twin	S3VA41TD	KS3VA41TD	KS3VA41TDB
	3VA61	600	150	Twin	S3VA52TD	KS3VA52TD	KS3VA52TDB
	3VA52, 3VA62	600	250	Twin	S3VA52TD	KS3VA52TD	KS3VA52TDB
	3VA53, 3VA63	600	400	Single	TBD	TBD	TBD
	3VA54, 3VA64	600	600	Single	TBD	TBD	TBD

¹ Strap Kit can also accommodate xGB breakers, reference Installation Instructions.

P5 Power Panelboards and Switchboard Circuit Breaker Kits – these kits contain parts to connect the breaker to the distribution

Panel Type	Existing / legacy Breakers	Max. Volts	Current Rating	Distributor Kit	Panelbuilder Kit	Hardware Kit	Steel Kit	Bus Kit	Aluminum Bus Kit
P5	BL	240	100	SBLBD	KSBLBD	KSBLBDH	KSBLBDS	KSBLBDB	—
	BQD	480	100	SBLBD	KSBLBD	KSBLBDH	KSBLBDS	KSBLBDB	—
	ED	600	125	SE6D	KSE6D	KSE6DH	KSE6DS	KSE6DB	KSE6DB-A
	CED	600	125	SCED	KSCED	KSCEDH	KSCEDS	KSE6DB	—
	DG	600	150	SDGD	KSDGD	KSDGDH	KSDGDS	KSDGDB	—
	QR	240	225	SQRD	KSQRD	KSQRDH	KSQRDS	KSQRDB	KSQRDBA
	FD	600	250	SF6D	KSF6D	KSF6DH	KSF6DS	KSF6DB	KSF6DB-A
	CFD	600	250	SCFD	KSCFD	KSCFDH	KSCFDS	KSCFDB	—
	FG	600	250	SFGD	KSFGD	KSFGDH	KSFGDS	KSFGDB	—
	JD (Single)	600	400	SJ1D	KSJ1D	KSJ1DH	KSJ1DS	KSJ1DB	KSJ1DB-A
	JD (Dual)	600	400	SJ2D	KSJ2D	KSJ2DH	KSJ2DS	KSJ2DB	KSJ2DB-A
	CJD	600	400	SCJD	KSCJD	KSCJDH	KSCJDS	KSCJDB	—
	SJD	600	400	SSJ1D	KSSJ1D	KSJ1DH	KSSJ1DS	KSJ1DB	—
	SCJD	600	400	SSCJD	KSSCJD	—	KSSJ1DS	KSCJDB	—
	JG (Single)	600	400	SJG1D	KSJG1D	KSJG1DH	KSJG1DS	KSJG1DB	—
	JG (Dual)	600	400	SJG2D	KSJG2D	KSJG2DH	KSJG2DS	KSJG2DB	—
	LD	600	600	SL6D	KSL6D	KSJ1DH	KSJ1DS	KSL6DB	KSL6DB-A
	CLD	600	600	SCLD	KSCJD	SCJDBH	KSCJDS	KSCJDB	—
	SLD	600	600	SSL6D	KSSL6D	KSL6DH	KSSJ1DS	KSL6DB	—
	SCLD	600	600	SCLD	KSCJD	—	KSSCJDS	—	—
	LG	600	600	SLGD	KSLGD	KSLGDH	KSLGDS	KSLGDB	—
	MD	600	800	SMND	KSMND	KSMNDH	KSMNDS	KSMNDB	—
	SMD	600	800	SSMND	KSSMND	KSMNDH	KSSMND	KSMNDB	—
	MG	600	800	MG1D	KMG1D	KMG1DH	KMG1DS	KMG1DB	—
	ND	600	1200	SMND	KSMND	KSMNDH	KSMNDS	KSMNDB	—
	SND	600	1200	SSMND	KSSMND	KSMNDH	KSSMND	KSMNDB	—
	NG	600	1200	NG1D	KNG1D	KNG1DH	KNG1DS	KNG1B	—

Note: When parts are not available use the full Panelbuilder kit. Distributor kit instructions can be used for installation and are available on the download center.

3VA Provision Kits¹

Breaker Type	Catalog Number
3VA52, 3VA61, 3VA62	S3VA52PR
3VA53, 3VA54, 3VA63, 3VA64	TBD

Contact Siemens Sales for availability

¹ Required when installing a 3VA breaker to an existing provision in the field. Parts are included with Distributor or Panelbuilder Kits.

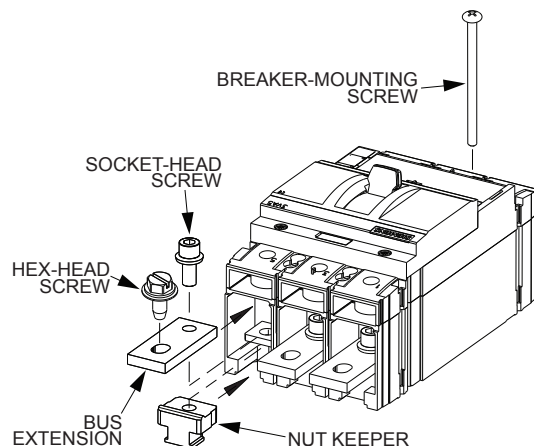
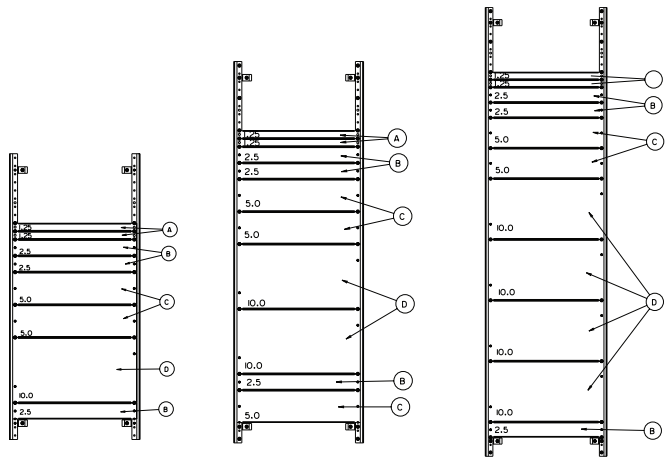

Figure 2 – 3VA Provision Kit Installation (3VA52)

Commonly used spare parts

Filler plates

Drawing image	Catalog number	Description	Mounting space used
	DFFP1A	BL/BQD/ED/xGB/GB2/3VA41	1"
A	6FPB01	Blank unit space plate	1.25"
B	6FPB02	Blank unit space plate	2.5"
C	6FPB03	Blank unit space plate	3.75"
D	6FPB05	Blank unit space plate	5"
E	6FPB10	Blank unit space plate	10"



Service entrance barriers

Breaker Type	Catalog Number
(S)JD, (S)LD, MG	SEBP4V1
CJD, CLD	SEBP4V2
JG, LG	SEBP4V3
(S)MD, (S)ND without shield	SEBP5V1
NG, (S)MD, (S)ND with shield	SEBP5V2

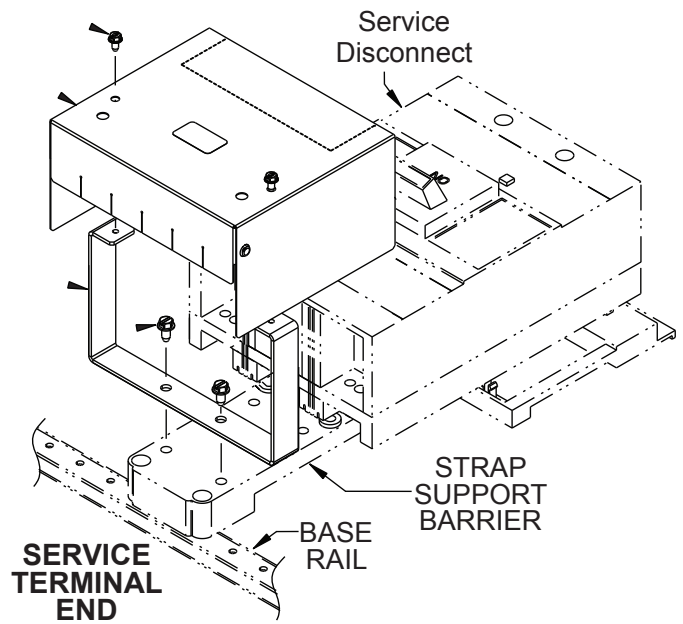

**Published by
Siemens Industry, Inc. 2021.**

Siemens Industry, Inc.
3617 Parkway Ln
Peachtree Corners, GA 30092

For more information, please contact
our Customer Support Center.

Phone: 1-800-241-4453

E-mail: info.us@siemens.com

usa.siemens.com/panelboards

Order No.: CBBR-AMPPS-0721

Printed in U.S.A.

© 2021 Siemens Industry, Inc.

The technical data presented in this document is based on an actual case or on as-designed parameters, and therefore should not be relied upon for any specific application and does not constitute a performance guarantee for any projects. Actual results are dependent on variable conditions.

Accordingly, Siemens does not make representations, warranties, or assurances as to the accuracy, currency or completeness of the content contained herein. If requested, we will provide specific technical data or specifications with respect to any customer's particular applications. Our company is constantly involved in engineering and development. For that reason, we reserve the right to modify, at any time, the technology and product specifications contained herein.